

RIEDL Phasys

Sophisticated Simplicity in Automation



Our vision

We don't just build systems, we build relationships.

We don't believe in standard services: we believe in work done right and in long-lasting, trust-based partnerships.

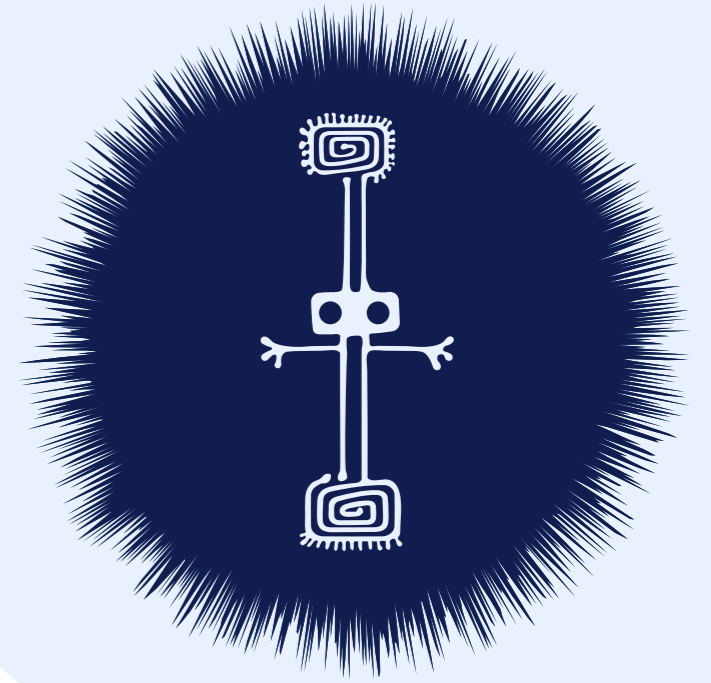

To innovate means to simplify.

To make work simpler, results more reliable, and people freer to focus on what truly matters. Our vision stems from this: helping those who work in healthcare and pharmaceutical distribution to experience a smoother and calmer daily routine.

We automate complexity.

We design systems that simplify the most complex and repetitive processes, freeing up valuable time, energy, and resources. The client is always at the center: we listen, collaborate, and build customized solutions, born from genuine dialogue and lasting relationships of trust.

We don't believe in standard services.

We believe in a job well done, in building solutions that work, and in taking care of our clients before, during, and after installation. We want to be chosen for who we are and for the value we offer. Every day, we work to earn that choice.



German Tech, Italian Style

Evolution in automation:
speed, reliability, accuracy
and a personalized design
for your pharmacy.



RIEDL Phasys is the system for the automated dispensing of drugs in the pharmacies, resulting from the partnership between a group of German engineers who have been working in the pharmacy automation sector for over twenty years and the GPI Group, which has been designing and developing IT solutions and services for health and social care in Italy and abroad for over thirty year.

The technology of the gripper represents the best one available on the market in terms of **speed, accuracy** and **reliability**.

The **customisation of every detail** makes RIEDL Phasys the only robot fully custom-made, according to the functional and aesthetic needs of each client.

RIEDL Phasys is one of the most advanced automation systems for pharmacies : fast, flexible, reliable.



Unique



Fast



Reliable



Energy-Saving



Wireless



Safe



Help 24/7



Handles standard and cylindrical packages

Unique

Just like your pharmacy:
no one is like yours.

We design and build your own RIEDL Phasys, according to your specific needs:

- it matches your style: finishes, shape, colour...
- it fits into your space: upstairs, downstairs or in a different room...
- it adapts to the daily handling of products
- it adapts to the number of workstations at the counter
- it adapts to the required capacity

The technological core becomes an integral part of the furniture.

You can choose among a wide range of finishes and colours for your RIEDL Phasys. By using the external shelves, which can be attached directly to RIEDL Phasys exterior panels, the front side of the system becomes a furnishing component, perfectly integrated in your pharmacy. Moreover, the external glass panels will let your customers enjoy the technological core of your pharmacy.



Have products delivered wherever you want in a few seconds.

You can customise the number and position of the outputs. Thanks to our ad-hoc delivery systems, each item can reach any point in your pharmacy (also on different floors) with an incomparable speed.

It fits into the available space.

Thanks to the different RIEDL Phasys configurations (L-U-I - Shape with built-in or external loading bay) the system can be adjusted to the structure of your pharmacy, thus being consistent with its style.

Fully customisable

Make space for your fantasy: RIEDL Phasys is so flexible that it will always find a place in your pharmacy.



Fast

Because your time is precious.

RIEDL Phasys bidirectional gripper moves at a speed of 5 meters per second and can dispense over 1,000 packages per hour*, drastically reducing order processing times.

No risk of medication falling.

Accurate handling of packages, even cylindrical ones, on both sides of the warehouse occurs without the need for gripper rotation, eliminating the risk of medication falling.

Automatic reading of expiry date.

RIEDL OCR is the innovative system for the automatic reading of expiry dates when loading and it is available also for semi-automatic loading. Managing drugs has never been so easy and fast!

Non stop loading system.

The **LTL (Load-To-Light)** semi-automatic multipicking loading enables to load up to 900 packs per hour with a single belt.

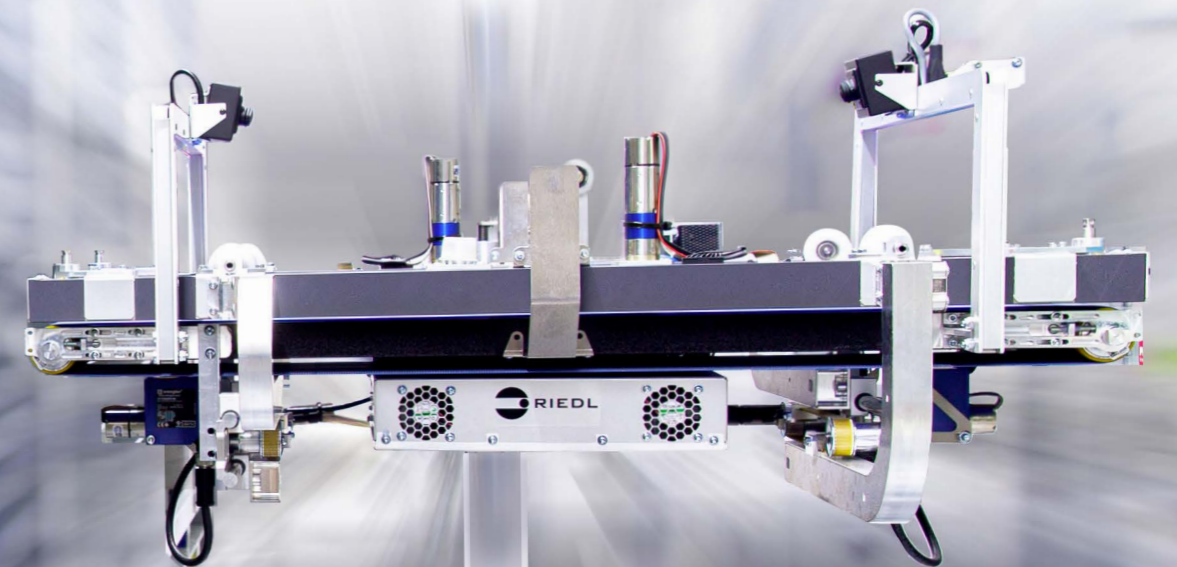

Automatic

It can do everything on its own.

Ultra Phasys is a revolutionary automatic loading system capable of manipulating all packages handled by RIEDL Phasys (including cylindrical packages). Developed in collaboration with leading research institutions, Ultra Phasys offers a loading performance of up to 360 packages per hour. It is optionally available for RIEDL Phasys systems and works even when the pharmacy is closed.

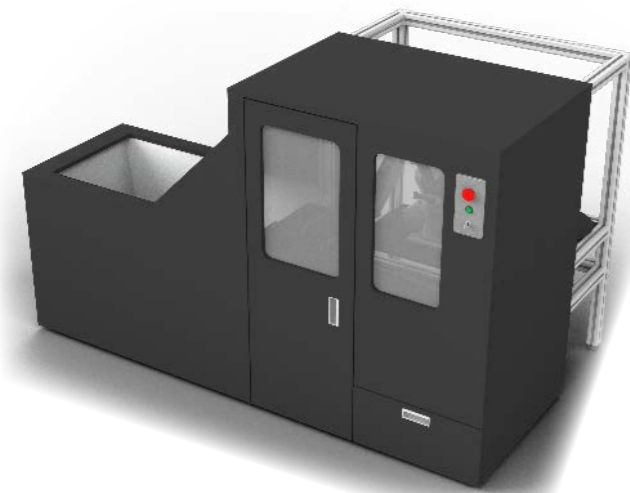

Fully Automatic Loading System

- 6-axis anthropomorphic robot to handle both cylindrical and square packages
- Smart singularization of products flow
- Item detection and classification system through a neural network
- Automatic expiry date detection on both cylindrical and square packages

Reliable

It never gets tired.

The precision in package handling, ensured by the system's automatic and real-time correction of the gripper's position, ensures high service continuity, eliminating inefficiencies and machine downtime.

Supports different shapes and products

Round or square, it makes no difference: you choose what to load into your RIEDL Phasys, and it takes care of the rest.



Wireless

No cables = More freedom

The connection between the gripper and the rest of the system occurs through a dedicated Wi-Fi network, meaning no cables. The system is quicker to install, easier to use, and maintain.

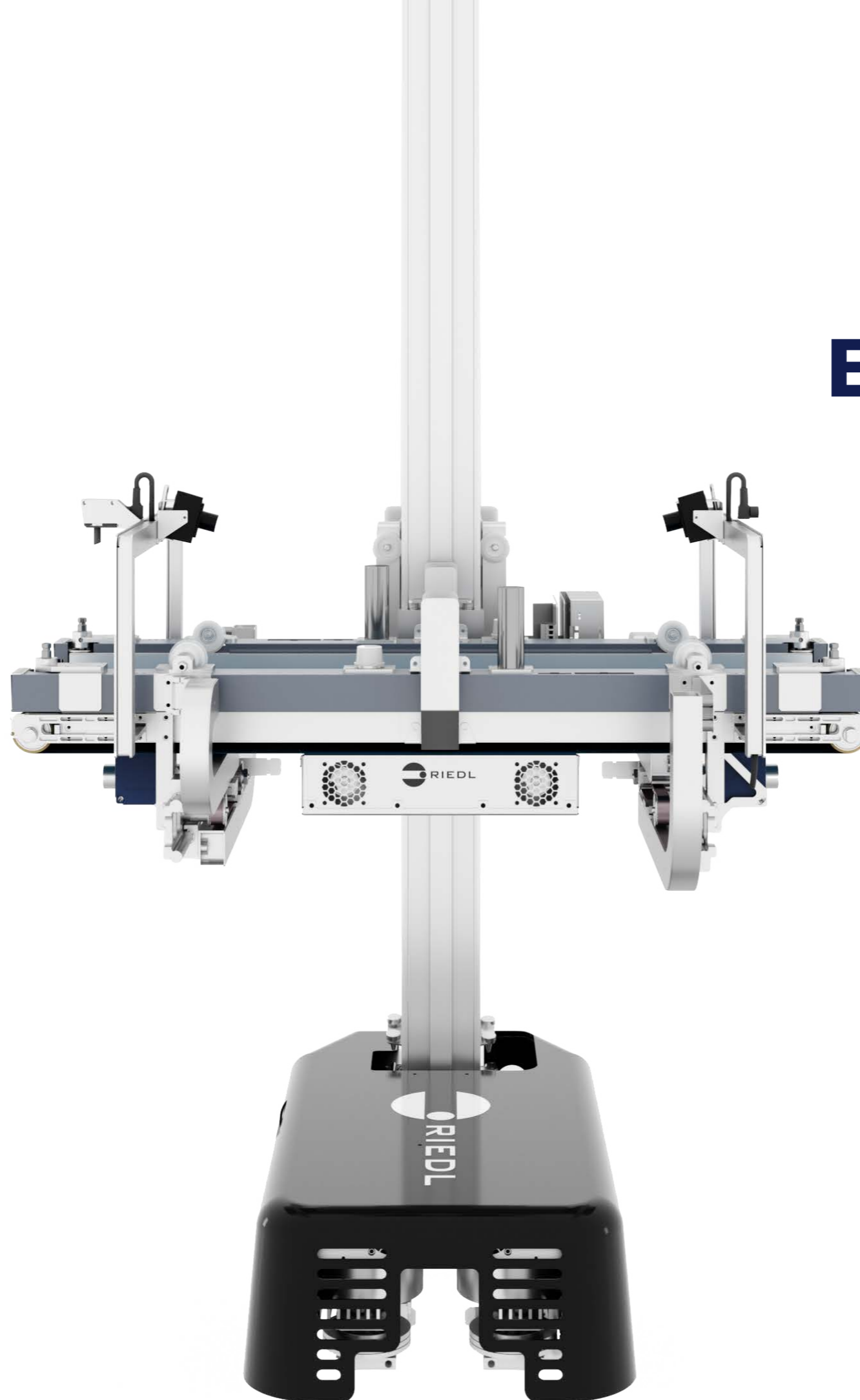

Energy-saving

A robot with "household" consumption

RIEDL Phasys consumes less than half a kWh, like a common household appliance. The lightweight gripper, reduced friction, and integrated KERS technology make the RIEDL Phasys system extremely cost-effective. And your bill is lighter too!



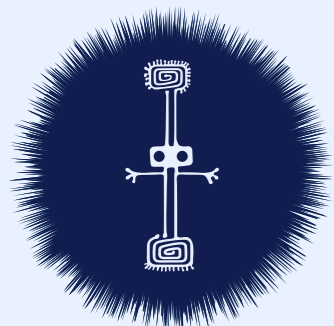

UPB Drawer

A new semi-automatic loading system,
as simple as it is effective.



Safe

High quality,
high protection.

All accesses inside the machine are protected by certified safety systems that, in case of opening, instantly block the movements of the gripper.

Assistance anywhere and immediately

The widespread presence of the GPI Group throughout Italy and abroad ensures prompt intervention and quick resolution of requests.

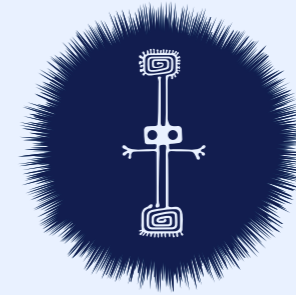

If you need
assistance, we're
always here for you!

GPI - Your Global Partner for a Better Future

GPI is the preferred partner for software, technologies and services dedicated to Health, Social Care and Public Administration.

Founded over 35 years ago in Trento, GPI has continuously grown thanks to significant investments in M&A (in Italy and abroad) and in R&D (in partnership with the leading universities and Italian research centres) in order to transfer the scientific, technological, functional and process knowledge applied to the e-health, e-welfare, and well-being sectors.

Thanks also to the solutions and skills acquired by companies that have be-

come part of its ecosystem, the Group has translated the drivers emerging from the world of Health Care into cutting-edge technological solutions and new service models able to optimise the processes of prevention, diagnosis, and care, improving people's quality of life.

The offer combines specialist expertise in IT and consultancy and design skills, which allow it to operate in different business areas: Software, Care, Automation and ICT.

www.gpigroup.com   

It follows the style of your pharmacy

RIEDL Phasys can be covered with standard panels or with customisable finishes to match with the style of your pharmacy. The use of glass panels (transparent or fumé) lets your customers enjoy the technological core of your pharmacy.

It fits into the available space

The different configurations of RIEDL Phasys enable the system to fit into the available space in your pharmacy.

Integrating part of the furniture

The use of external shelves, that can be attached directly to the main structure of RIEDL Phasys, let the front side of the system become a furniture component integrated in your pharmacy.

Have drugs delivered wherever you want, in few seconds

The number and the position of the output points are customisable. With the optional delivery systems, packs can reach any point in the pharmacy at an incomparable speed of each gripper.

Storing drugs has never been so easy... and fast

The semi-automatic multi-picking loading system of RIEDL Phasys is accurate and easy to use. It enables to load up to 900 packs per hour. For each pack it's possible to enter its expiry date and batch with a single click, if required. Also available with RIEDL OCR option for automatic recognition of expiration date.

Safety first

All entries inside the machine are protected by certified security systems which, in case of opening, instantly stop the gripper.

Light bill

The low friction, the low weight of the gripper and the integrated KERS allow to reduce to the minimum medium and peak consumption (similar to common household). For this reason RIEDL Phasys doesn't require any adjustment of the electrical system of your pharmacy.

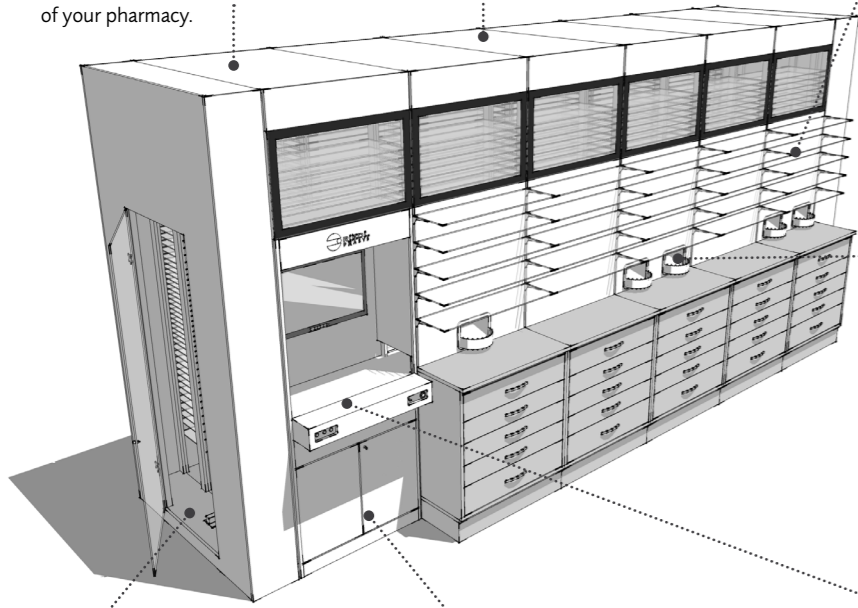

Technical Datasheet

Dimensions	Width	1.606 mm/ 63.23 Inch
	Height	from 2.219 mm/87.36 in to 3.519 mm/ 138.54 in (pitch 100 mm/3.94 in)
	Length	from 3.768 mm/148.23 in, no maximum limit
Performance	Semi-automatic loading	operator time: ~3 sec. per package machine time: ~300 packages/hour in single picking (up to 900 packages/hour in multipicking*)
	Automatic loading (optional)	Up to 360 pack/hour
	Unloading	~360 packages/hour in single picking ~650 packages/hour in multipicking **
		* multipicking factor in loading: 3 ** average multipicking factor in unloading: 1.8
Accepted packs	min. size	12 x 10 x 40 mm / 0.47 x 0.39 x 1.57 in
	max. size	180 x 120 x 300 mm / 7.08 x 4.72 x 11.81 in
	min. diameter	40 mm / 1.57 in
	max. diameter	180 mm / 7.08 in
	max. weight	1.200 g / 2 lb 10.33 oz per pack (max. weight on gripper: 2.500 g / 5 lb 8.185 oz)
Barcode	1D and 2D	
Voltage	230V±10% 50/60 Hz	
Transport system	Conveyor belts, spiral chutes (diameter 410 mm), lifts, pneumatic tube	
Optional components	Additional gripping units ● Fully automatic loading system ● Phasys Cleaning System ● Basket Phasys automatic replenishment system ● RIEDL OCR reading and recognition system for the expiry date ● RIEDL Integrated Drawers ● Phasys 24 vending machine	
Safety	UPS, computer backup, remote monitoring, rapid replacement of the gripper, automatic alignment of packs on the shelves.	

Layout

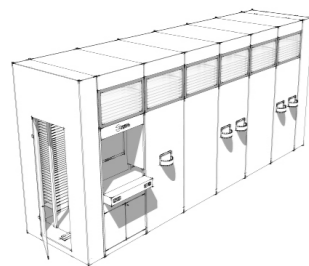

I - Shape

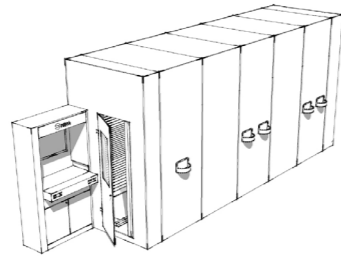

External Loading Bay

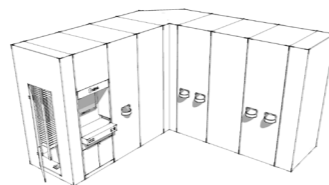

L-Shape

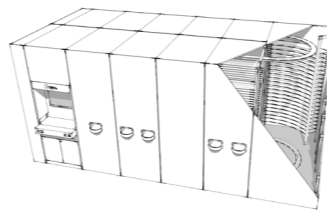

U-Shape

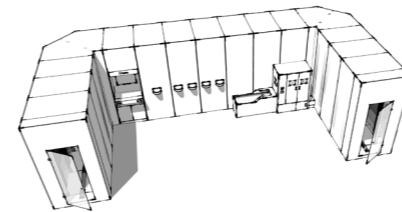

C-Shape

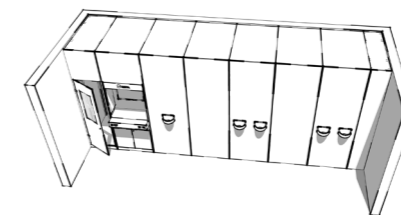

Front Door

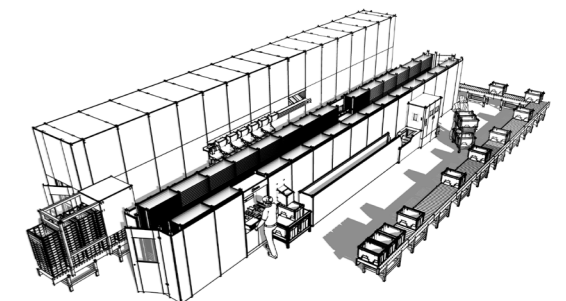

Big Systems

GPI SpA

I-38123 Trento (TN)
Via Ragazzi del '99, n. 13
T+39 0461 381 515

sales@riedlautomation.com
riedlautomation.com

